

# QUICK START GUIDE

for IBEE series 3D printer

## UNPACK YOUR SYSTEM

### A Pull the printer out.

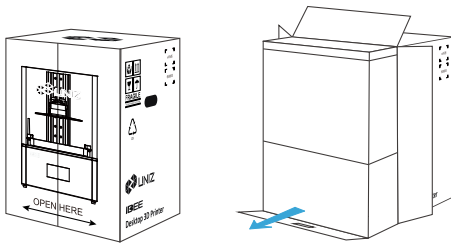

- ⚠ Please keep the original box and protectors in case of future shipping or storing.  
\*Detailed packing list is in the box.

## SET-UP YOUR PRINTER

### B Position the printer.

- Place the printer on a leveled desk.
- Adjust the four leveling screws under the printer to level it.

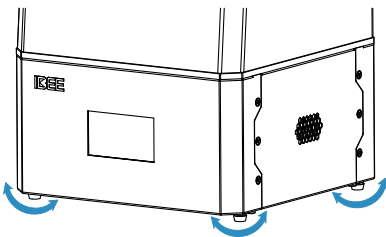

- ⚠ Operate at room temperature (18-28°C). Keep out of direct sunlight or other intensive light sources.

### C Check the Build Platform.

- Make sure the Build Platform is locked onto the ARM firmly.
- Turn the lock handle anticlockwise will unlock the Platform.

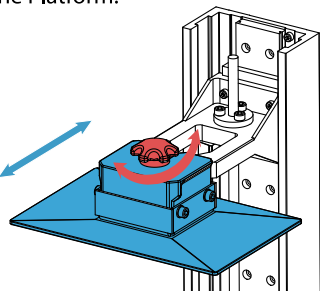

### D Check the Resin Tank.

- Turn the lock handle will lock or unlock the Resin Tank.

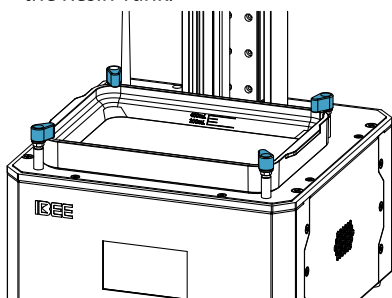

- Check the Resin Tank, the film should be intact.

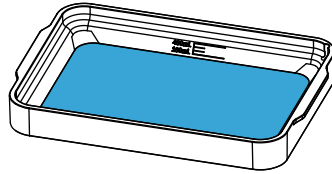

- Check the protective film on the LCD.

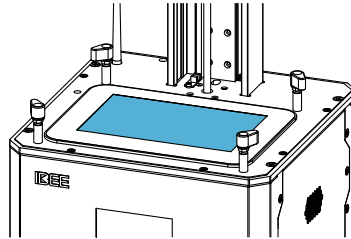

- ⚠ Paste a new film if the old one is broken.

- Put the Resin Tank back and lock it.

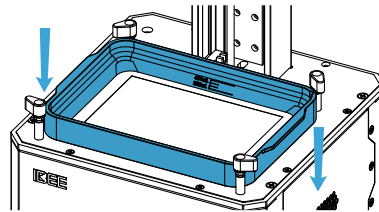

### E Load the Resin.

- Take the Cap off the Resin Bottle.
- Pour the resin into Resin Tank directly.
- Put the Cover back.

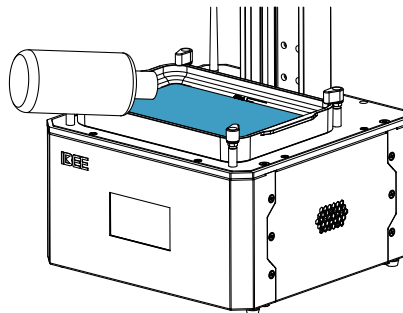

### F Light it up.

- Connect power adapter and cable.
- Toggle the switch to ON.
- Connect to your computer via USB cable.

\*The system will enter the initializing tutorial the first time you turn on the printer, please follow the steps to set up your printer, after finished the tutorial would never show again.

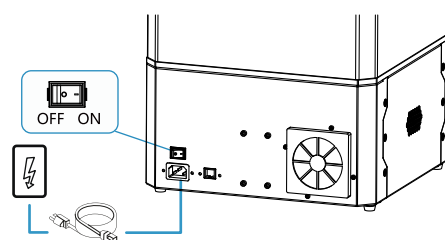

- ⚠ Make sure the Power Adapter is connected firmly to ensure stable power supply.

## START A PRINT

### H Prepare to print.

- Take out the USB disk with UNIZ logo.

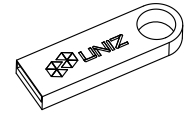

- Insert the USB disk from the left side of the printer.

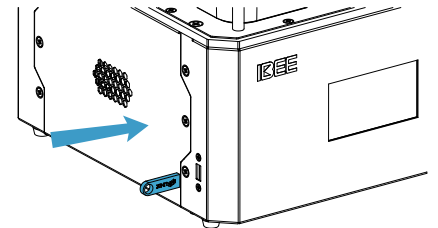

- Click PRINT to enter the file management page, click USB DISK to import slice files from USB disk.

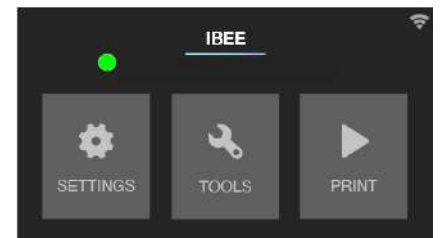

- Searching the file list and select the slice file you want to print.

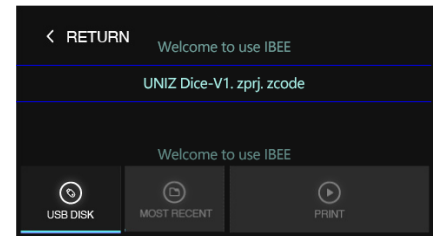

- Click PRINT to start the printing process, printing details will show up.



### I Finish Printing

- Wipe up the remaining resin on the Build Platform, then loose the lock screw and take the Build Platform out.
- Use the shovel to remove the models.

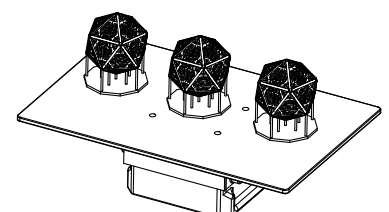

\*For more details, please check User Manual and Software Help Documentation.